

CANEO

series40 Puck

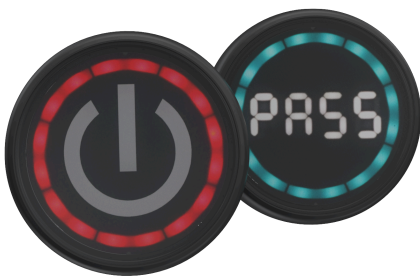

Product image



Dimensional drawing

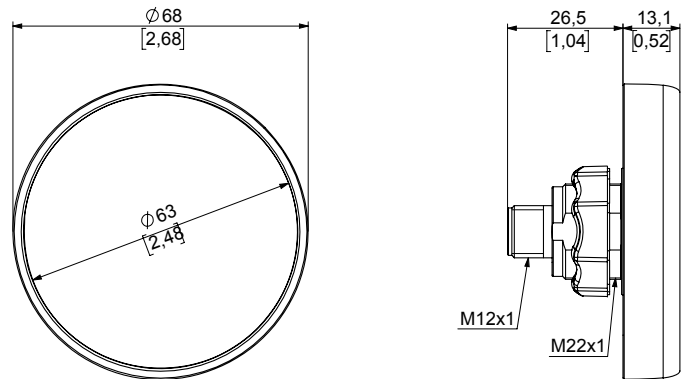

Connection plan

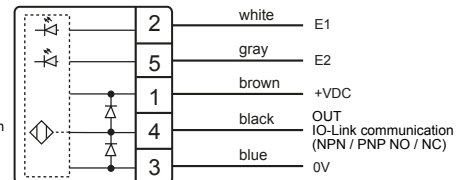
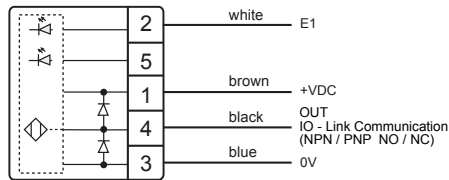
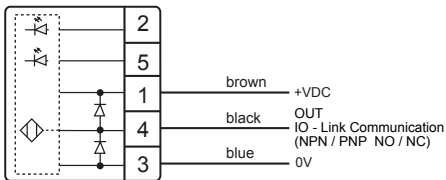

Plug

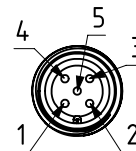
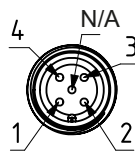
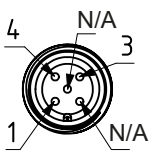



Technical specifications

series4x	
Operating voltage	DC 12 - 24 V (8.4 to 31.2 V)
Load current	max. 200 mA
Output	Adjustable PNP / NPN; NO / NC
Length of output pulse	Adjustable
Reverse polarity protection	Protection of all cables/lines
Short circuit protection	Protected against short circuit and overload
Voltage drop	Max. 2.5 V at 200 mA load current
Power consumption at 24 V	Max. 90 mA
Operating temperature	-25°C (-13°F) to 50°C (122°F)
Degree of protection IP	Front IP69K Maximum unevenness in mounting surface < 0.2 mm
Degree of protection IK	IK08
Communication interface	IO-Link specification V1.1
Measuring principle	Capacitive
Type of actuation	Touch
Actuation force	No actuation force required
max. altitude	3000 m above standard zero
Relative air humidity	Max. 95%, non-condensing